

Palsonic

The AUSTRALIAN Company

80cm (31.5") D-LED TV / DVD Combo WITH DVB-T

INSTRUCTION MANUAL TFTV8070MW

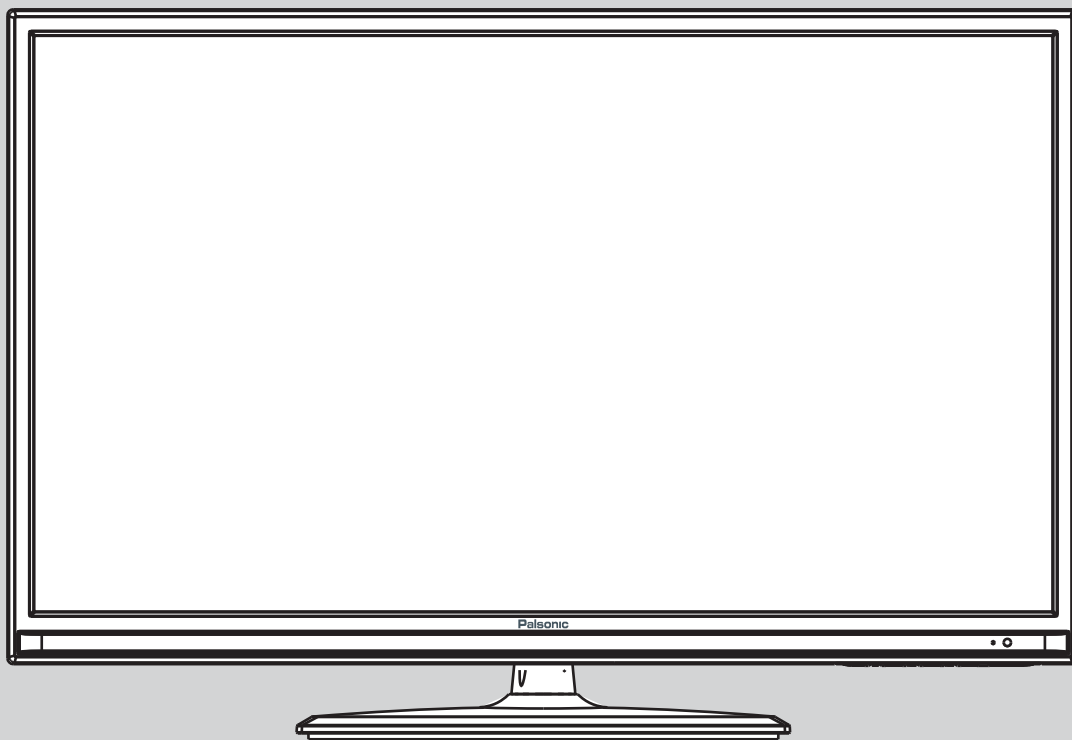

*Where available

*Where available



Contents

Power Supply.....	1
Installation.....	2
Use and Maintenance.....	3
Important Safety Instructions	4-5
Overview(Front View) / Accessories	6
Overview(Back View)	7
Remote control	8-9
Basic Operation	10
OSD Menu	
1. PICTURE Menu	11
2. SOUND Menu	12
3. CHANNEL Menu	13-14
4. FEATURE Menu	15-16
5. SETUP Menu	17
Multimedia Operation	
Multimedia Operation	18-20
Recording Operation	
Recording Operation	21-23
DVD operation	
DVD operation	24-31
Simple Troubleshooting	32
Specifications	33

Overview

Front View

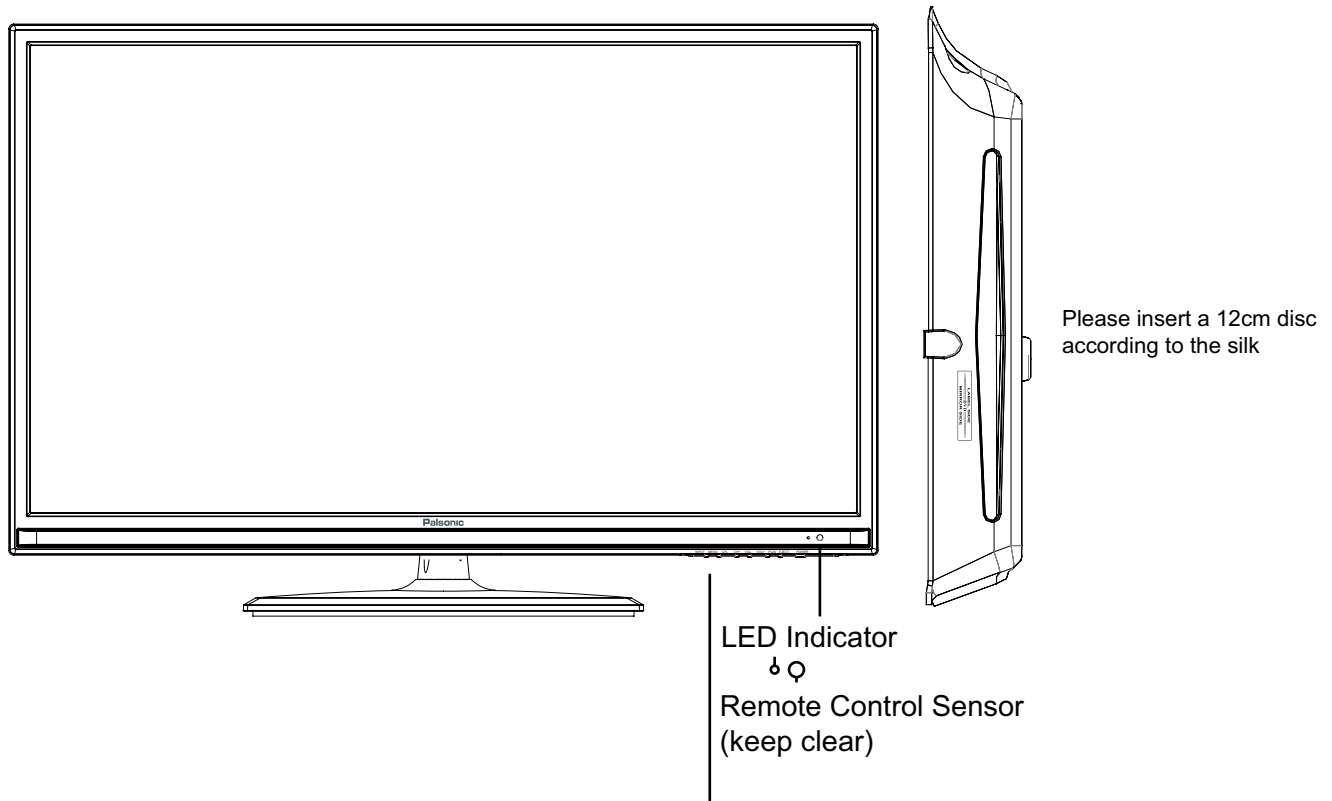

- MENU:** Display/exit the OSD menu.
- CH+/-:** Scan through channels.
- VOL+/-:** Adjust the volume.
- INPUT:** Display the input source menu.
- PLAY:** Play / Pause the disc playing
- EJECT:** Eject the disc.
- POWER:** Turn on/standby the TV set.

Accessories

● The configuration of the components may look different from the following illustration.

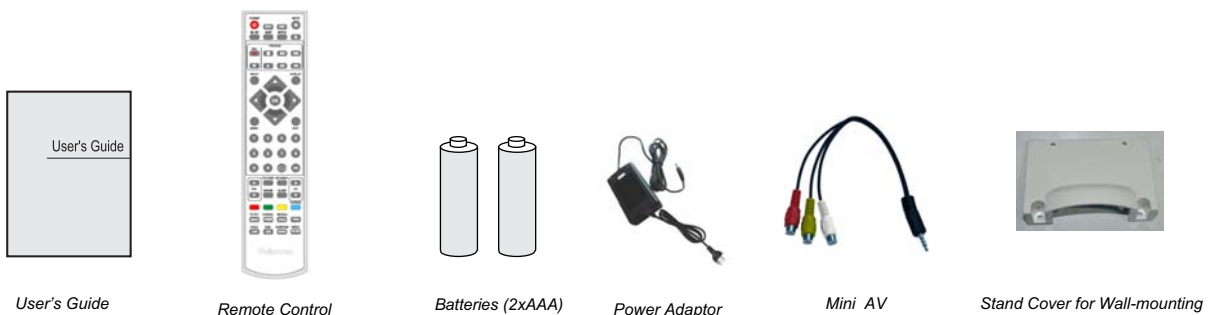

Overview

Back View

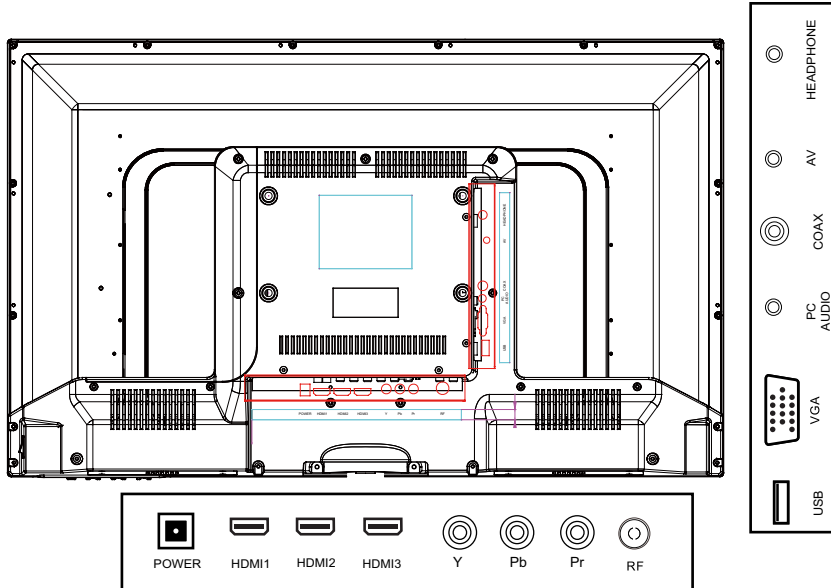

POWER: Connect to the power.

HDMI 1/2/3: Connect it to the HDMI of DVD or other equipment.

YPbPr: Connect them to the YPbPr video output terminal of DVD.

RF: Connect antenna or cable 75 Ohm coaxial to receive TV signal.

USB: USB jack for Recording and Media.

VGA: For PC display. Connect it to the D-Sub 15 pins analog output connector of the PC.

PC AUDIO: Connect it to the audio output terminal of PC.

COAX: Digital output to AV receiver.

AV: Connect it to video output terminal of DVD.(shared with YPbPr)

HEADPHONE: Connect it to your headphone or other audio equipment.

Wall Mounting

The TV is provided with mounting holes for a VESA (200x100mm) approved wall mounting bracket (NOT SUPPLIED). Remove the Posi screws holding the base to the base bracket and lift the base away (do not remove the base mounting bracket), fix the Stand Cover. Mount the VESA bracket using 4xM5x10mm ISO metric threaded screws (not supplied). Do not use screws longer than 10mm, it will occur damage to the internal parts. Fit the wall bracket securely following the manufacturers instructions.

*** Please assemble the stand cover into the unit in order to protect your unit while using the wall mount.**

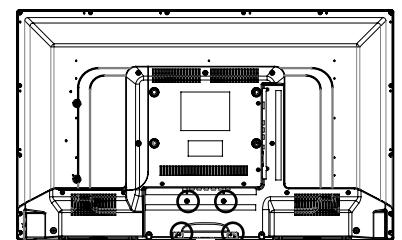
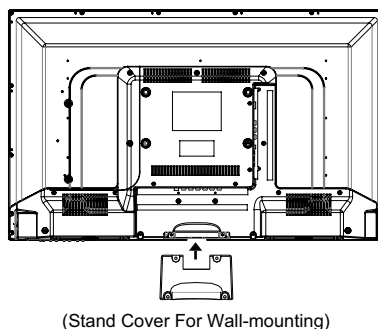
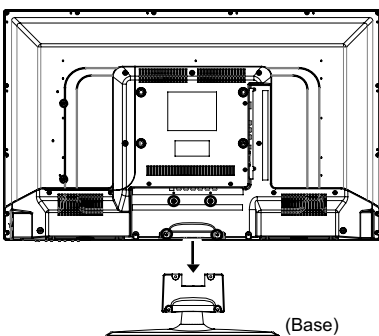

1. Insert the stand Cover for Wall-mounting in the bottom of the TV.
2. Attach the Stand Cover with the supplied screws.

Remote Control

● Functions of remote control buttons

The remote control is using Infra-Red (IR). Point it towards the front of the TV. The remote control may not work correctly if it is operated out of range or out of angle.

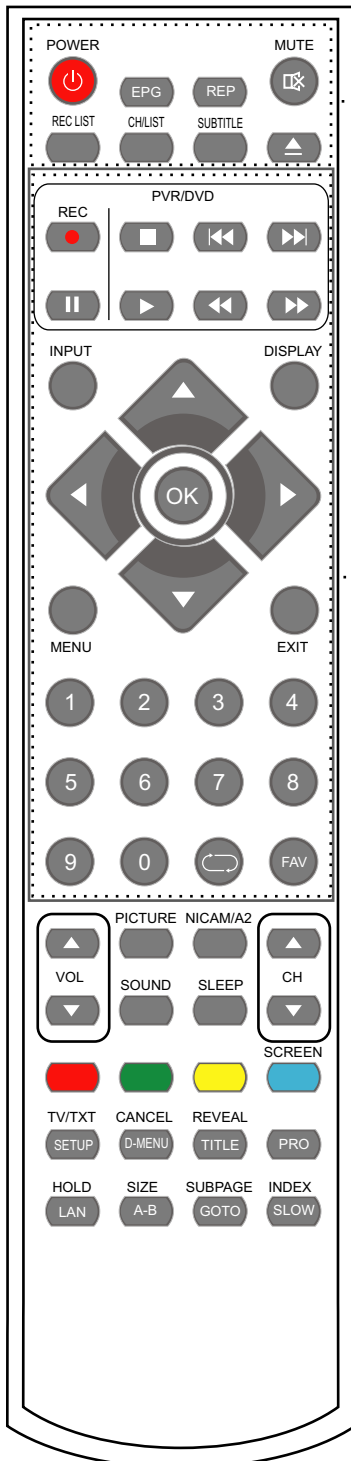

POWER: Turn the TV on/standby.
MUTE: Press to mute the sound, press again or press VOL+ to unmute.
REC LIST: Record List.
CH/LIST: Display the programs list.
SUBTITLE: Turn on/off the subtitle display in DTV mode and DVD mode.
EPG: To show the Electronic Program Guide during no-menu state only in DTV mode.
REP: Repeat playing the title or chapter.
▲ : Load/eject DVD disc.

PVR/DVD

REC ● : Press to start record the program in DTV mode.

- : Stop program.
- ◀◀ : Previous chapter.
- ▶▶ : Next chapter.
- || : Pause program.
- ▶ : Play program.
- ◀◀ : Fast reverse.
- ▶▶ : Fast forward.

INPUT: Press to display the input source menu.

DISPLAY: Press to display the current mode's information.

* In DTV mode, play display one time, display the basic information.

Play a second time, display the detail information.

Play a third time to exit.

MENU: System setup menu.

EXIT: Exit the OSD menu.

FAV: Display the favorite program list.

NUMBER BUTTONS

Press 0-9 to select a TV channel directly when you are watching TV.



Return to the previous channel viewed.

CURSOR KEYS (▲/▼/◀/▶/OK)

Allows you to navigate the on-screen menus and adjust the system settings to your preference.

Remote Control

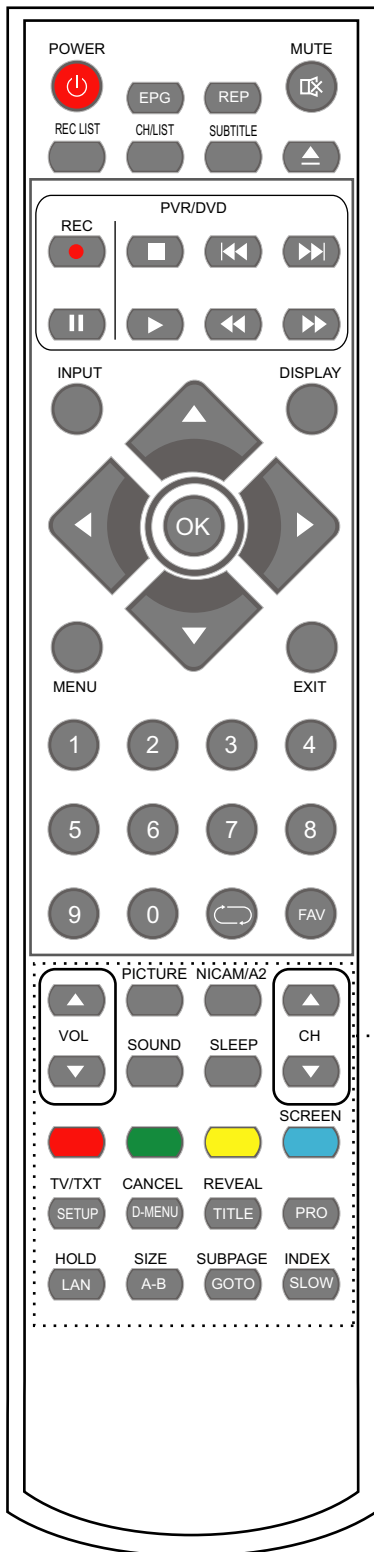

CH▲/▼: Scan through channels.
 VOL▲/▼: Adjust the volume.
 PICTURE: Select the picture mode.
 NICAM/A2: TV Nicam/A2 select.
 SOUND: Select the sound mode.
 SLEEP: Standby timer.
 SCREEN: Turn on/off the screen.
 TV/TXT: Turn off/on the Teletext display.
 CANCEL: Cancel the Teletext display.
 REVEAL: Reveal any hidden text.
 HOLD: Hold or carry on the current subpage.
 SIZE: Press to see top half of page double size,
 Press again to see the bottom
 half of page double size. Press again for normal size.
 SUBPAGE: Press to enter subpages, press again to cancel.
 INDEX: Go to index.
 Colour buttons: Short cuts-follow the coloured links in the text

SETUP: DVD system setup.
 D-MENU: DVD play list/Disc menu.
 TITLE: DVD title.
 PRO: Edit the program and play.
 LAN: Select DVD disc language.
 A-B: Select and play the preferable paragraph of DVD program
 by pressing this key twice at the beginning and end of it.
 GOTO: Play your favorite title/chapter/track.
 SLOW: Play DVD programs at slow speed.

Basic Operation

Power on/off

1. Connect to the power supply with an adaptor.
2. -To turn on the TV
Press **POWER** button on the TV or remote control.
-To turn off the TV
Press **POWER** button on the TV or remote control.

Input Source select

Press **INPUT** button on the TV set or remote control to display the input source menu, and use **CH+/-** button on the TV set or **^/∇** button on remote control to select the input source, press **OK** button on the remote control to enter.

Note: Before you select the input source, make sure the connections are prepared.



Basic OSD Menu operation

Press **MENU** button to display the OSD menu as below:

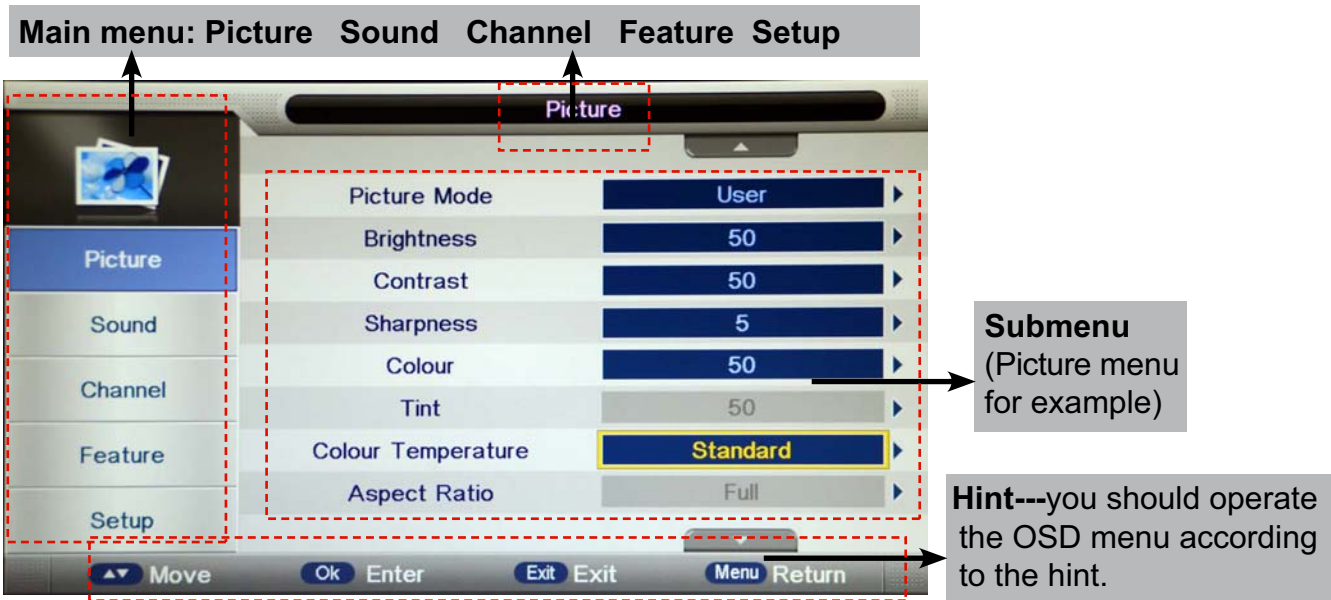

Use **^ / ∇** button to select the main menu, and press **> / OK** button to enter the submenu. In the submenu, use **^ / ∇** button to select the function item, press **> / OK** button to enter the setup menu, then press **< / >** button to adjust, or press **^ / ∇** to select and press **OK / < / >** button to confirm.

* (Press **MENU** / **<** button to return to the upper menu.)

* (Press **EXIT** button to exit the menu display.)

Note1: Only when you input the suitable signal, the relevant items can be activated

Note2: Please operating the OSD menu according to hint on the bottom of the banner.

OSD Menu

1. Picture menu



Description

Picture Mode: Select your desired picture mode from Dynamic, Standard, Mild and User.

Brightness: Adjust image black level.

Contrast: Adjust image contrast.

Sharpness: Adjust the sharpness(Gray and invalid in VGA/PC mode).

Colour: Adjust image colour from black and white.

Tint: Control the tint (NTSC mode only).

Colour Temp.: Select an optimum color temperature mode to suit your eyes for viewing from Warm, Cool, Standard.

Aspect Ratio: Change the aspect for the screen from 4:3,16:9, full, Zoom1, Zoom2 etc...

Noise Reduction: If the broadcast signal received is weak, you can select the Noise Reduction option to reduce the video noise level between Off, Low, Middle and High.

OSD Menu

2. Sound menu



Description

Sound Mode: Select your desired sound mode from Standard, Movie, Music, Speech and User.

Bass: Adjust the level of the lower-pitched sounds.

Treble: Adjust the level of the higherpitched sounds.

Balance: Adjust the audio output between left and right speakers.

Surround: Turn on/off the surround sound function.

Auto Volume Level (AVL): The volumes of all sources will be maintained when the function's on.

SPDIF: Select the spdif mode for the TV from off, PCM and Auto.

OSD Menu

3. Channel menu(In ATV/DTV mode)

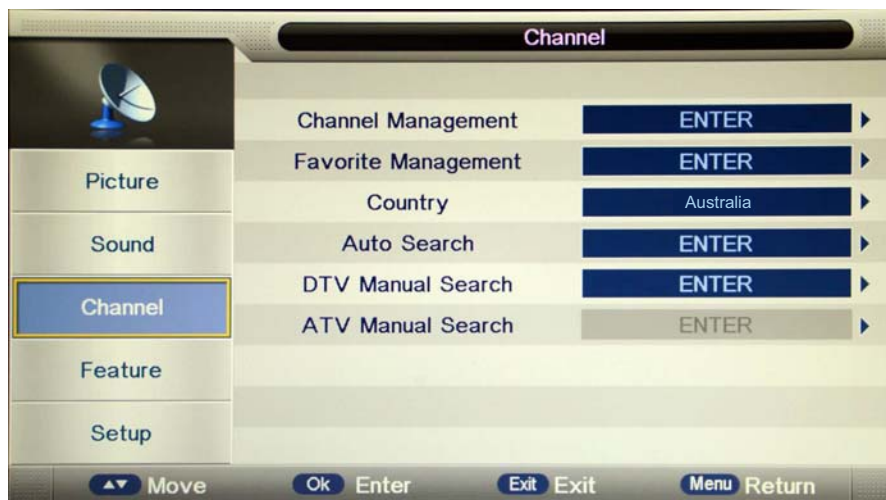

Description

Channel Management: Enter the Channel management menu to edit the channels.



Delete: Press **RED** button to sign the channels you want to delete, it will hint you when you exit.

Lock:User must set the "Lock enable"(Feature-Lock- Lock enable) at ON to active this function.

Press **GREEN** button to sign(lock) or cancel(unlock) the channel. And you have to enter the password to view the program.

Skip: Press **YELLOW** button to skip the channel or cancel the setting, and the program will not be programed by CH+/- button.

Swap: Press **BLUE** button to sign the channel, press \wedge / \vee button to move, and press OK button to swap the position.

Rename: Press **OK** button to enter the rename menu to rename the ATV channel.

Favorite Management: Add or remove favourite channels by the colour buttons.

Up to 4 favourite lists are available, RED-Fav1, GREEN-Fav2, YELLOW-Fav3, BLUE-Fav4.

Note: You could display the Favourite list 1/2/3/4 by press the FAV button once/twice/three times/ four times.



OSD Menu

Country: Select the country.

When the Child Lock is on, please enter the Password (Lock Password in Feature menu) to start Auto and Manual Search.

Auto Search: Press OK button to enter the Auto Search menu, select search mode, and press OK button to start auto search.

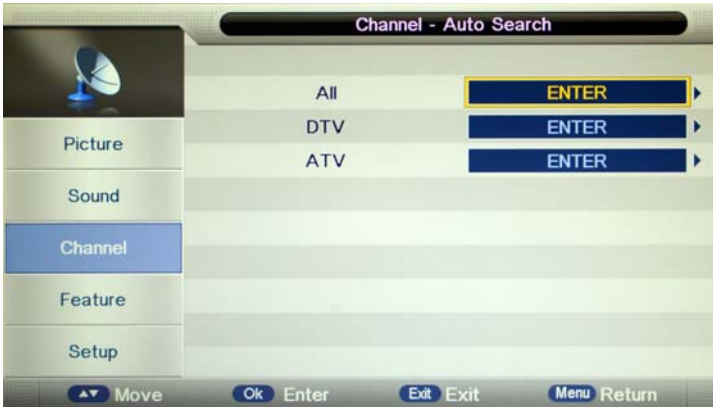

Note:

1. ALL: Auto search channels for DTV, ATV and Radio.
DTV: Auto search channels for DTV and radio.
ATV: Auto search channels for ATV.

2. When the TV is auto tuning, you could press MENU button to stop auto tuning and return to preview menu.

DTV Manual Search : Enter the DTV Manual Search menu.

Press \wedge / \vee button to select the “Channel” item, and press \lt / \gt button to select the channel, then press \wedge / \vee button to select the “Start” item, and press \lt / \gt button to manual search.

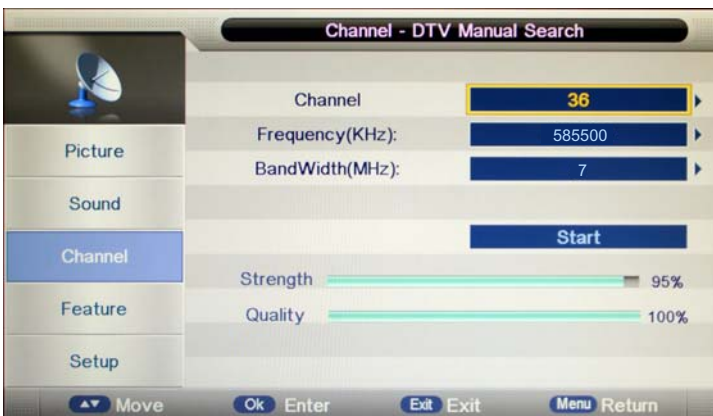

ATV Manual Search : Enter the ATV Manual Search menu.

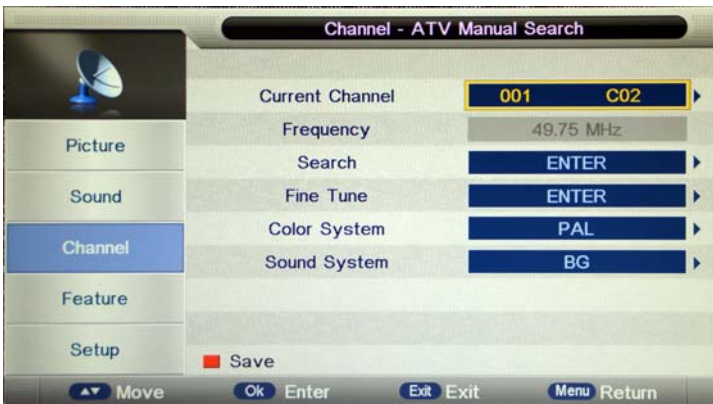

Current Channel: Select the current channel for manual searching.

Search: Press OK button to enter the search menu, and manual search the frequency by \lt / \gt button.

Fine Tune: Press OK button to enter the Fine tune menu, and fine tune the frequency by \lt / \gt button.

Color/Sound System: Select the Color/Sound system for the program.

OSD Menu

4. Feature menu



Description

Lock: This menu allows you to lock certain features of the television so that they can not be used or viewed. For example if you don't want certain channels viewed by children or if the television is to be used in a hotel and you want certain channels be locked.

When you enter the system lock menu you will be asked for a password. As default it is 0000.

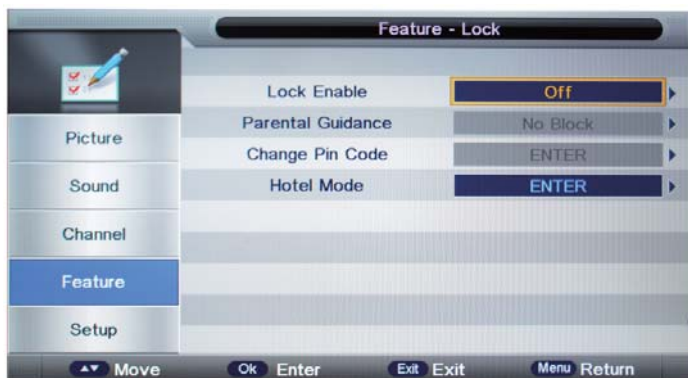

Lock Enable - Turn on/off the Lock Channel function.

Note: When it is be turned on, the functions of Parental Guidance and Change Pin code below will be locked, and the functions Lock(in Channel Management), Auto Search, DTV Manual Search, ATV manual Search in Channel menu will also be locked.

Parental Guidance - Select the Parental Guidance mode, or turn off the function.

Change Pin Code – Press OK button to enter , first enter the current code, then enter your new code and confirm your new code.

OSD Menu

Hotel Mode - Enter the Hotel Setting menu.

Hotel Setting	
Hotel Lock	Off
Channel Lock	Off
Picture Lock	Off
Sound Lock	Off
Feature Lock	Off
Setup Lock	Off
Key Lock	Off
Source Lock	-->
Set Source	Off
Channel Number	0
Max Volume	100
Default Volume	30
Clear Lock	-->
DataBase Export	-->
DataBase Import	-->

Hotel Lock: Turn on/off the Hotel Lock function.
Channel Lock: Disable the Channel menu in OSD.
Picture Lock: Disable the Picture menu in OSD.
Sound Lock: Disable the Sound menu in OSD.
Feature Lock: Disable the Feature menu in OSD.
Setup Lock: Disable the Setup menu in OSD.
Key Lock: Disable the buttons on the TV set.
Source Lock: Disable the input source you desired.
Set Source: Select the default source when you turn on the TV.
Channel Number: Select the default channel number when you turn on the TV.
Max Volume: Set the Max volume for the TV.
Default Volume: Set the default volume when the program is on.
Clear Lock: Clear all the locks above, it means set all the locks to OFF and max volume to 100.
Database Export: Export all Hotel Settings to the USB device.
Database Import: Import all Hotel Settings from the USB device.

Language: Lets you adjust the different language options available.

Clock: Allows you to set the time zone (as default the information is taken automatically from the digital signal).

Sleep Timer: Lets you set the sleep timer so the television automatically switches off after a certain amount of time.

Auto Power Off: The TV will switch off itself automatically if no change in status within the time you select. You can choose 1H, 2H, 4H or off.

Hearing Impaired: You can switch on the hearing impaired feature, this provides additional information and subtitles

PVR/Timeshift: Setup menu for recording, please see the Recording Operation section.

OSD Menu

5. SETUP menu



Description

OSD Timer: Lets you adjust the amount of time the On Screen Menu stays on the screen before disappearing.

PC Setup: Change the PC Settings in PC mode.



Auto Adjust: Setup the parameter of the screen automatically.

H/V-Position: Adjust the transverse/vertical position of the screen.

Phase: Adjust the phase of the ADC sampling clock relative to the sync signal, until a stable image is obtained.

Clock: Adjust the pixel clock frequency, until the image size is maximized for the screen.

Blue Screen: Changes the background when there is no input between clear and a blue background (Only available in some sources).

Reset TV Setting - This clears all the TV settings for the television.

Software Upgrade: From time to time we may release new firmware to improve the running of the television (available to download). This menu lets you upgrade that software onto the television. Further details of how to do this will be issued with the firmware. Contact the helpline or refer to the 'product support' section of the website.

Multimedia Operation

Basic Operation

1). Press the INPUT button on the remote control to display the input source menu, select Media source by the ▲ / ▼ buttons, and press OK button to enter the Multimedia menu as shown below.



2). Insert USB device, and select the Media mode form Photo, Music, Movie and eBook, then you will find the name of the device display on the screen as shown below.



Hints for operation

3). Press ▲/▼ button to select the USB device and press OK button to enter the file list as shown below.



Press ▲ / ▼ buttons to move (press OK button to select the file or unfold the folder);
 Press **RED** button to delete the file; Press **GREEN** button to sign or cancel all the files to playlist;
 Press **OK** button to sign or cancel the selected file to playlist.
 Press < button to previous menu, Press **EXIT** button to select the file view type: list(<) or thumbnails(>).
 Press Exit again to return to the root MENU.
 Then press ► button to program the files (be signed) you select or the files in the fold you select.
 Press ■ button to stop and exit the full screen program, please notes the hints on the bottom.

Multimedia Operation

1. Photo

Play the photo



Press ◀/▶ button to select the option on the table, and press **OK** button to change.

Note: You could press OK button to display the option table when it disappears.

▶/|| Play/Pause the photo playing.

■ Stop and exit the full screen program.

◀▶ Play the previous or next file directly.

↻ Rotate the picture(0, 90, 180, 270).

🔍 Zoom in/out the picture, you could move the picture by Cursor left/right/up/down button in Zoom mode.

ⓘ Display the information of the current file.

⚙ Display the photo setup menu, and select the Repeat mode, Background Music, Slide Time, Effect.

☰ Display the playing list.

2. Music

Play the music



Press ◀/▶ button to select the option on the table, and press **OK** button to change.

▶/|| Play/Pause the music playing.

■ Stop and exit the music playing.

◀▶ Play fast backward or forward.

◀▶ Play the previous or next file directly.

⏮ Select the repeat mode for playing music.

☰ Switch the window between "Information" and "Playlist".

☒ Switch off the screen displaying (BLUE button as quick button), and it will be turned on by exepet power button).

Multimedia Operation

3. Movie

Play the movie



Press ◀/▶ button to select the option on the table, and press **OK** button to change.

Note: You could press OK button to display the option table when it disappears.

- ▶/|| Play/Pause the movie playing.
- Stop and exit the full screen program.
- ◀◀ ▶▶ Play fast backward or forward.
- ▶ Play the movie in slow mode.
- ▶| Play the movie in step mode.
- ↺↻ Set the A-B repeat playing mode.
- ◀ ▶ Play the previous or next file directly.
- ☰ Display the playing list.
- ⓘ Display the information of the current file.
- ⚙ Display the movie setup menu, and setup the Program, Subtitle, Audio, Repeat mode.
- 🕒 Goto mode, Input the time and start playing directly.

4. eBook

Play the text

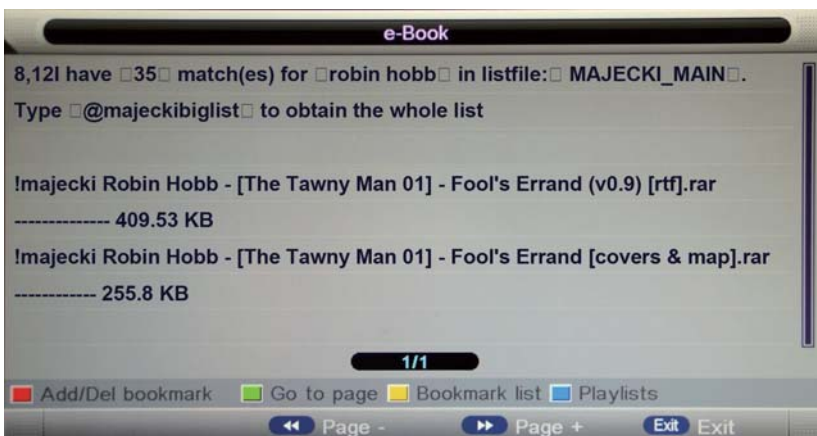

◀◀ ▶▶ Turn to previous/next page of the text.

RED button: Add or delete the bookmark.

GREEN button: Goto the appoint page.

YELLOW button: Display the bookmark list.

BLUE button: Display the playlist.

Recording Operation

PVR settings

Press the MENU button select Feature-PVR/Timeshift menu, press OK button to enter the menu as below.



1). Record File Format

Select Record File Format mode from TS and PS for storing in the USB device.

2). Partition Select



— USB device informations

Format: Press **RED** button to format the selected USB device.

Set Default Partition: Press **GREEN** button to set the focus partition as the default partition. The recorders are stored in the default partition. It need to be reset if the default partition is full in recording progress.

3). Timeshift Buffer

Set Timeshift Buffer mode: auto, 30Mins, 1hr, 2hr.

4). Timer

Enter the Timer menu to setup the timer recording settings.



→ Press yellow button to add.



Recorder: Turn on/off the recorder function.

Type: Select the type of the program you want to recording.

Channel: Select the channel you want to recording.

Start Time: Setup the start time for recording the program.

Duration: Setup the duration time for recording.

Date: Select the date for recording.

Mode: Select the mode for recording.

Recording Operation

5). Record List

Display the Record list menu.



Delete: Press RED button to delete the selected record plan.

6). Recorder Start

Press **OK** button to start recording, as the function of the **REC** button on the remote control.

EPG and Timer Record

Press **EPG** button on the remote control to display the EPG menu.



EPG mode: Press RED button to change the EPG display mode.

Daily mode: shows the information of the programs to be broadcasted in daily mode.

Weekly mode: shows the information of the programs to be broadcasted in weekly mode.

Reminder: Press GREEN button once to remind the program for watching, and press GREEN button again to remind the program for recording. You could check it in Timer menu, and the TV will record the program according to your settings automatically.

Previous/Next Day: Press YELLOW/BLUE button to display the programs on previous or next day.

Recording Operation

Recording

Press **REC** button on the remote control to start recording in DTV mode, and the TV will give you a hint. Select "OK" item, and press OK to start recording, there will be a sign on the screen.



Note:

- Please make sure the USB device is on the TV.
- Please make sure the speed and free space of the USB is enough.
- Press STOP button to exit the recording mode.
- Press Recording list button to display the Recorder list, and you could play the program you selected. The recording will be going on, and the Recording menu will display when you exit the Recorder list.
- You could also play the Recorded program in Multimedia mode.

Timeshift

Press **II PAUSE** button on the remote control to start timeshift in DTV mode, and the TV will give you a hint. Select "OK" item, and press OK to start timeshift, there will be a sign on the screen, and the screen will be frozen.



Note:

- Please make sure the USB device is on the TV.
- Please make sure the speed and free space of the USB is enough.
- Press STOP button to exit the timeshift mode.
- Press PLAY button to play the program you are recording from the beginning, and the timeshift will be going on.
- Timeshift time menu on the right top corner shows the fallen time between the current picture and the living broadcasting picture;
- During the recording progress, if the signal is missing, the recording process will take a pause until the signal is stable again.

DVD Operation

Basic Operation

Press the Power button on the TV or the remote control, then press the INPUT button to select DVD mode. If there is no disc in the DVD player the screen will show "NO DISC".

Insert Disc according to picture next to disc slot.

Do not touch the playing surface.

Hold the disc around the outside with your fingers and place the disc into the slot. The player will automatically draw the disc into the player.

To "Eject" the disc, press the EJECT button on the TV or the "▲" button on the remote control.

DVD Setup Mode

- Setup Mode provides the menu for the configuration of General Setup Page, Audio Setup Page, Dolby Digital, Setup, Preference Page.
- Item selection in the Setup Menu is done by using the Navigation Arrows, SETUP button and the OK button.
- Press the SETUP button first, enter into SETUP menu, then press the DIRECTION RIGHT button, you can enter into the next Sub-menu.
- Press the SETUP button again to exit the Setup Menu.

General Setup

TV Display

• 4:3 Pan Scan

This is selected when the DVD player is connected to a normal TV. Wide-screen images are shown on the screen, but with some parts cut automatically.

• 4:3 Letter Box

This is selected when the player is connected to a normal TV. Wide-screen images are shown on the screen, with black belt on the top and bottom.

• Wide

This is selected when the player is connected to a wide-screen TV.



DVD Operation

OSD Language

This is used to select the OSD language.



Screen Saver

Start the screen saver, the screen saver image will appear when the player stops or the picture is frozen for a few minutes. This saver can keep the screen from being damaged.

- **On** (Start the screen saver)
- **Off** (Remove the screen saver).

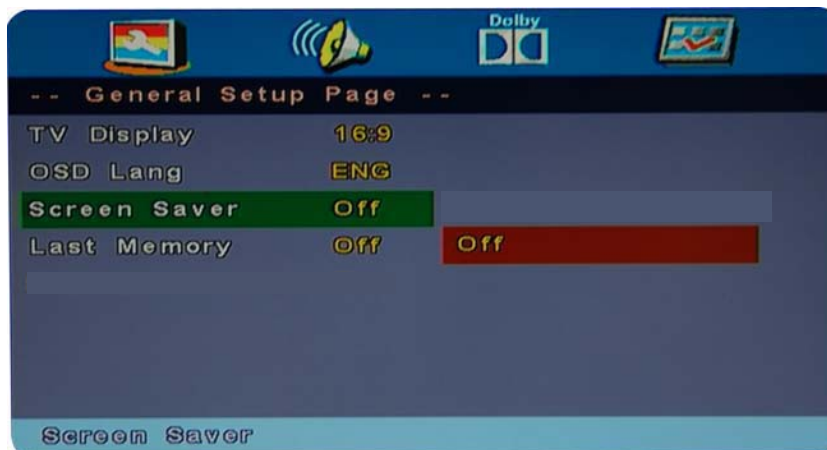

Last Memory

Can set the items on the last memory, "on" and "off" option.

Select "On", the shutdown will shutdown the machine before the settings for memory, re-boot the machine settings. Set near the same time.

Select "Off", every time the machine automatically switched back to the default settings

- **On** (Start the memory)
- **Off** (Remove the memory).

DVD Operation



AUDIO Setup

- **Speaker Setup**

In the "Audio Setup page" press "▼" button to select "Speaker Setup" item, press the "OK ENTER" or "▶" button (play) into the "Speaker Setup Page".

DVD Operation



Downmix

- **LT/RT**

A disc recorded multi channel soundtrack, the output signal will be incorporated to left and right channel.

- **Stereo**

A disc recorded multi channel soundtrack, The output signal will be incorporated to stereo.

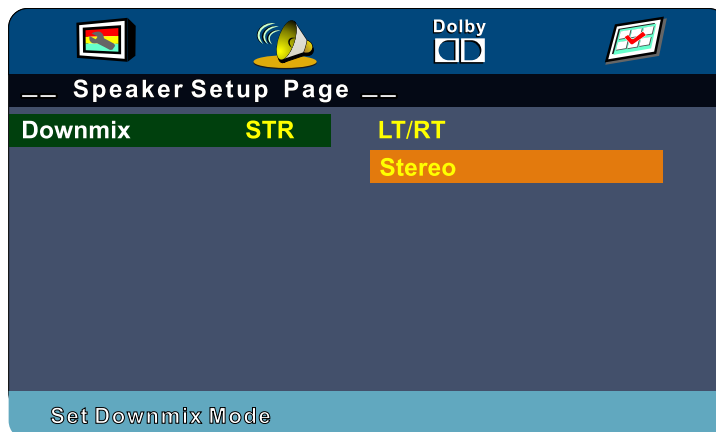

DVD Operation

Dolby Digital Setup

Dynamic

This option is used to set the compression ratio in order to control the sound (Volume) contrast.

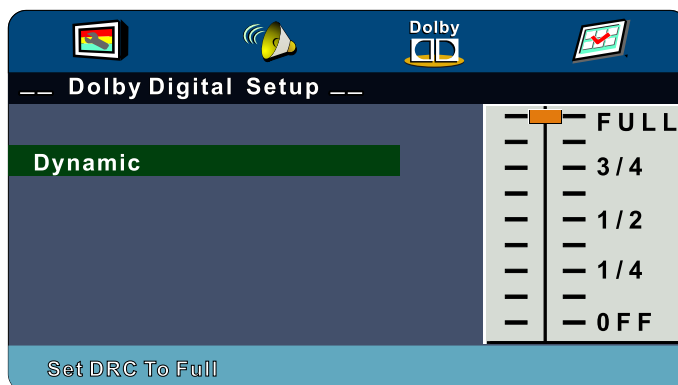

Preference Setup

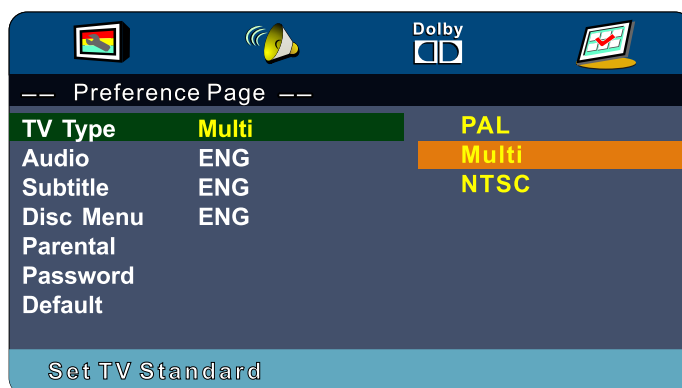

You must press **STOP** twice to enter Preference Page or NO disc

TV Type

- **PAL**

This is selected when the player is connected to an PAL System TV.

- **MULTI**

The player will set the TV system according to the disc in the tray.

- **NTSC**

This is selected when the player is connected to a NTSC System TV.

Audio

If a language listed below is recorded on the disc, you can play the sound in such language.

If not, the language recorded will be used.

DVD Operation

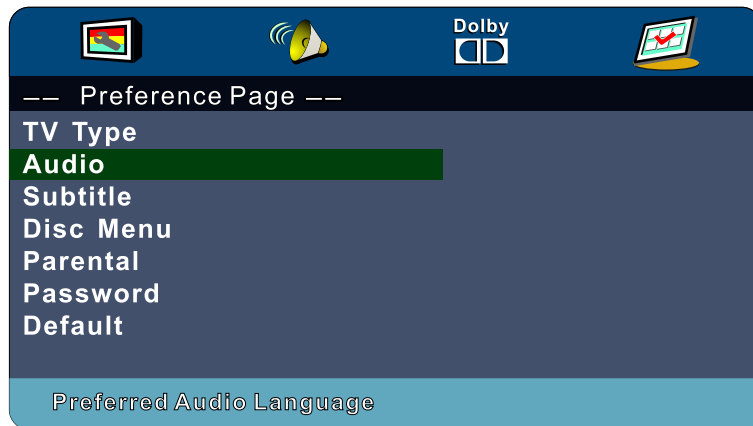

Subtitle

If a language listed below is recorded on the disc, you set the subtitle to be displayed in such language. If not, the language recorded will be used.

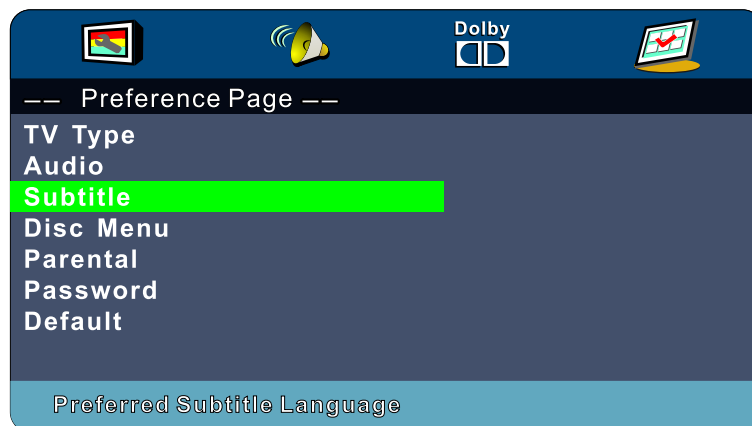

Disc Menu

If a language listed below is record on the disc, you can set the Menu to be displayed in such language. If not, the language recorded will be used.

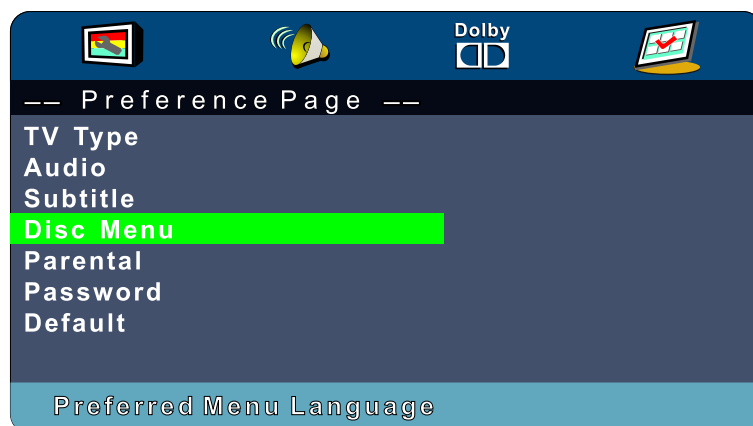

DVD Operation

Parental

When playing disc with parental lock function, you may select an Age Control Grade according to grade of disc and your own preference. For example, if PG is selected, DVD Video disc rated higher than the PG grade cannot be played.

- KID SAF
- G
- PG
- PG 13
- PGR
- R
- NC 17
- ADULT

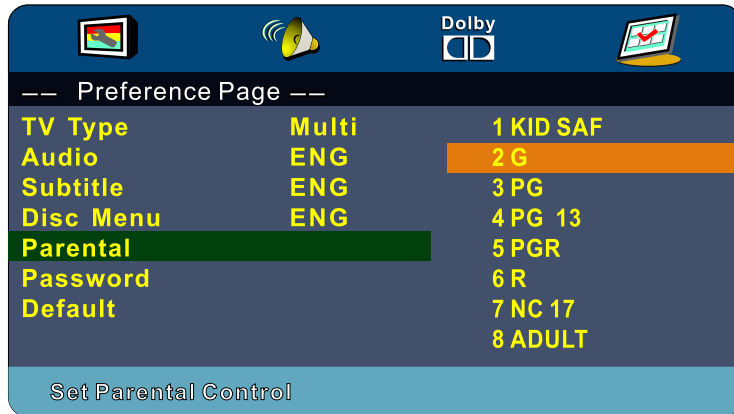

Password

User can change the password that is required when the user wants to change the Age Control Grade in the Parental Lock function.

NOTE:(Default password is 123456)

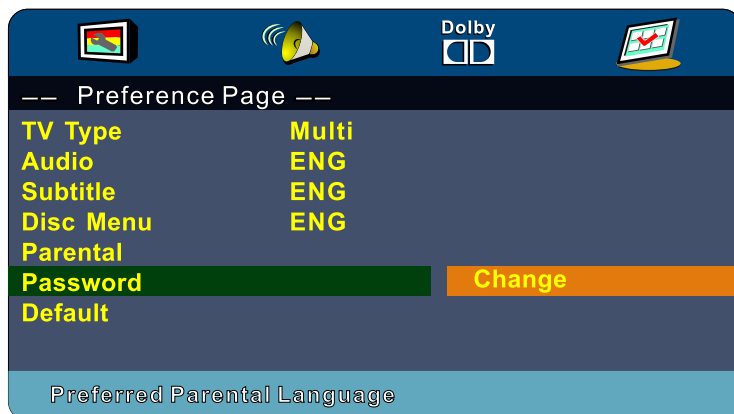

DVD Operation

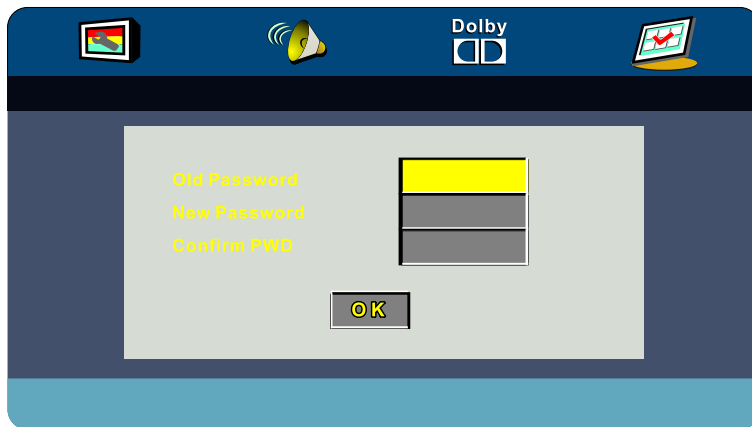
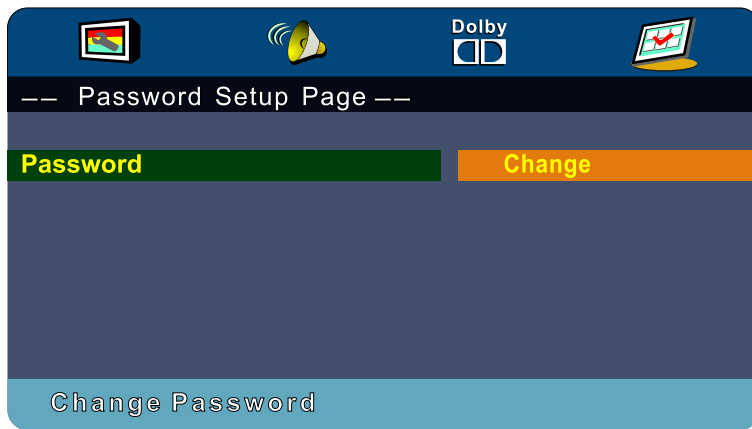

Default

User can load the original factory setting by choose RESET and press OK button .



Simple Troubleshooting

If the display fails or performance dramatically deteriorates check the Display in accordance with the following instructions. Remember to check the peripherals to pinpoint the source of the failure.

If the display still fails to perform as expected, connect your helpline for assistance.

No power

- Check all connections to the TV.
- Press either the power button or the Standby button on the Remote control.

No picture or sound

- Ensure that the TV is plugged in and the power is on.
- Ensure that the aerial is connected.
- Try a different programme.

Poor picture quality

- Check the aerial connections.
- Check that the channel is tuned in properly.
- Adjust the picture settings: brightness, colour, sharpness, contrast, hue.
- Make sure that the TV is not located close to electrical appliances that may emit radio frequency interference.

No colour

- Adjust the colour setting.
- Check that the programme is broadcast in colour.
- Check that the channel is tuned properly.

TV does not respond to remote control

- Check that there are no obstructions between the remote control and the unit.
- Check that the remote control is within range of the unit.
- Check that the batteries in the remote control are not weak or exhausted.

This TV is for household use and registered as harmless on electromagnetic waves. Therefore, you can use it in every location as well as residential areas.

Specifications

LCD Panel	Panel Size	31.5"
Max. Resolution		1366 x 768
Input Connector	VIDEO	1
	YPbPr	1
	VGA	1
	AUDIO (L/R)	1
	PC AUDIO	1
	HDMI	3
	RF	1
	USB	1
Output Connector	HEADPHONE	1
	COAX	1
Main Voltage		12V = 5A
Power		60W

IMPORTANT NOTICE:

This product composes up to 6.0 million cells and a few cell defects may occur In the manufacture of the panel. Several dead pixels (allow up to 2 bright or 2 dark pixels) on the panel are deemed acceptable by the industry standards. In line with manufacturers and would not mean that the panel is faulty. Dead pixels panels with 6 pixels or more within 12 month period, Palsonic Corporation Pty Ltd. complies with industry standard and reserves the right to repair the unit and non-refundable. We hope you will understand that the product that corresponds to this standard is regarded as acceptable.

Palsonic

The AUSTRALIAN Company

Palsonic Customer Service
Telephone (Australia) 1300 657 888

Palsonic Corporation Pty Ltd ABN 34 000 474 108
1 Joynton Avenue, Waterloo NSW 2017 Australia

Telephone (02) 9313 7111 Facsimile (02) 9697 0655
www.palsonic.com.au

